

LIQUID LEAK SENSOR INSTALLATION GUIDE



INFRASENSING



Overview

InfraSensing's leak sensor is an industrial grade solution to detect leaks inside data centers, server rooms, commercial buildings, gas tanks, UPS, outdoor cabinets, power rooms and any other critical facility or infrastructure.

Used with our base unit, the SensorGateway, it will alert you via SMS, email, voice call or SNMP traps.

Through Modbus TCP and SNMP it integrates with any major Building Management system and Network Monitoring system.

What you need

Base Unit SensorGateway



Leak Sensor + Cable

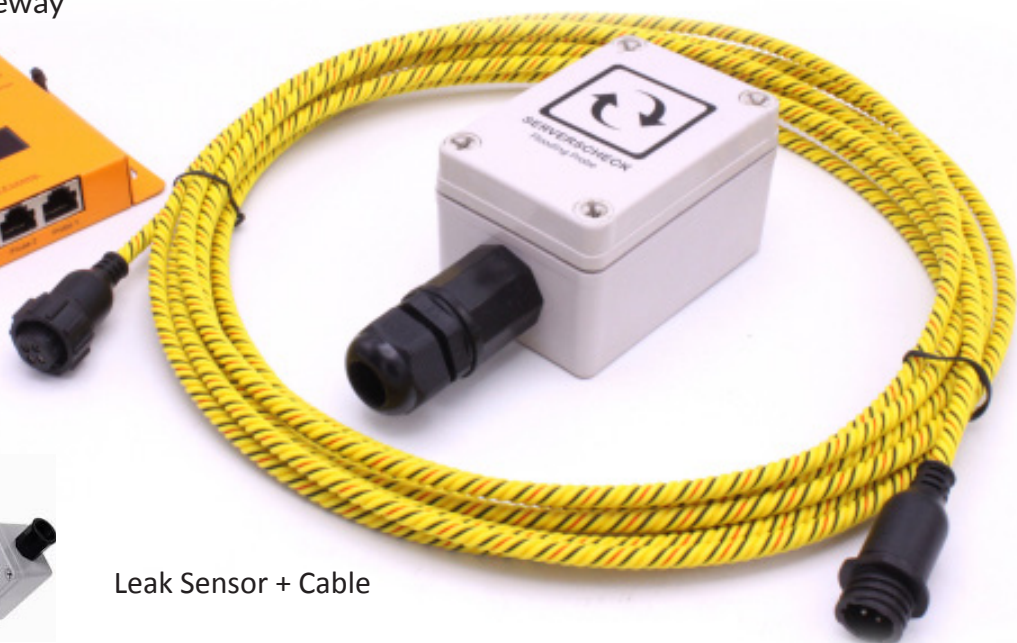

To start things up, first you would need our SensorGateway (BASE-WIRED), then our Leak Sensor plus one of our various leak sensing cables (for Water, Fuel or Battery/Acid). Each cable has a default length of 5m/16ft and can be extended up to 200m/656ft(water leak) or 125m/410ft(water leak location). Custom cable lengths are available.

For pricing and ordering info please visit:
https://infrasensing.com/sensors/sensor_flooding.asp



Do's + Don'ts before & during installs

Do's

- Store the sensing cable in its original container and in a clean dry area prior to installation.
- Schedule of installation should be done after major construction work is completed to avoid damage or contamination of the cable.
- Clean the area where the sensing cable is to be installed
- Remove any debris or other source of contamination

Don'ts

- Drag sensing cable through contaminants (Dirt , Oil, cement, solvents, etc)
- Use damaged or contaminated sensing cable
- Solder or weld near the cable (can be done if the cable is protected from heat, flux and splatter)
- Drop sharp or heavy objects onto the cable
- Pull the cable with excessive force
- Use adhesive tapes or clamping devices to secure the sensing cable
- Allow cable connectors to become wet, dirty or contaminated



General layout of leak sensor setup

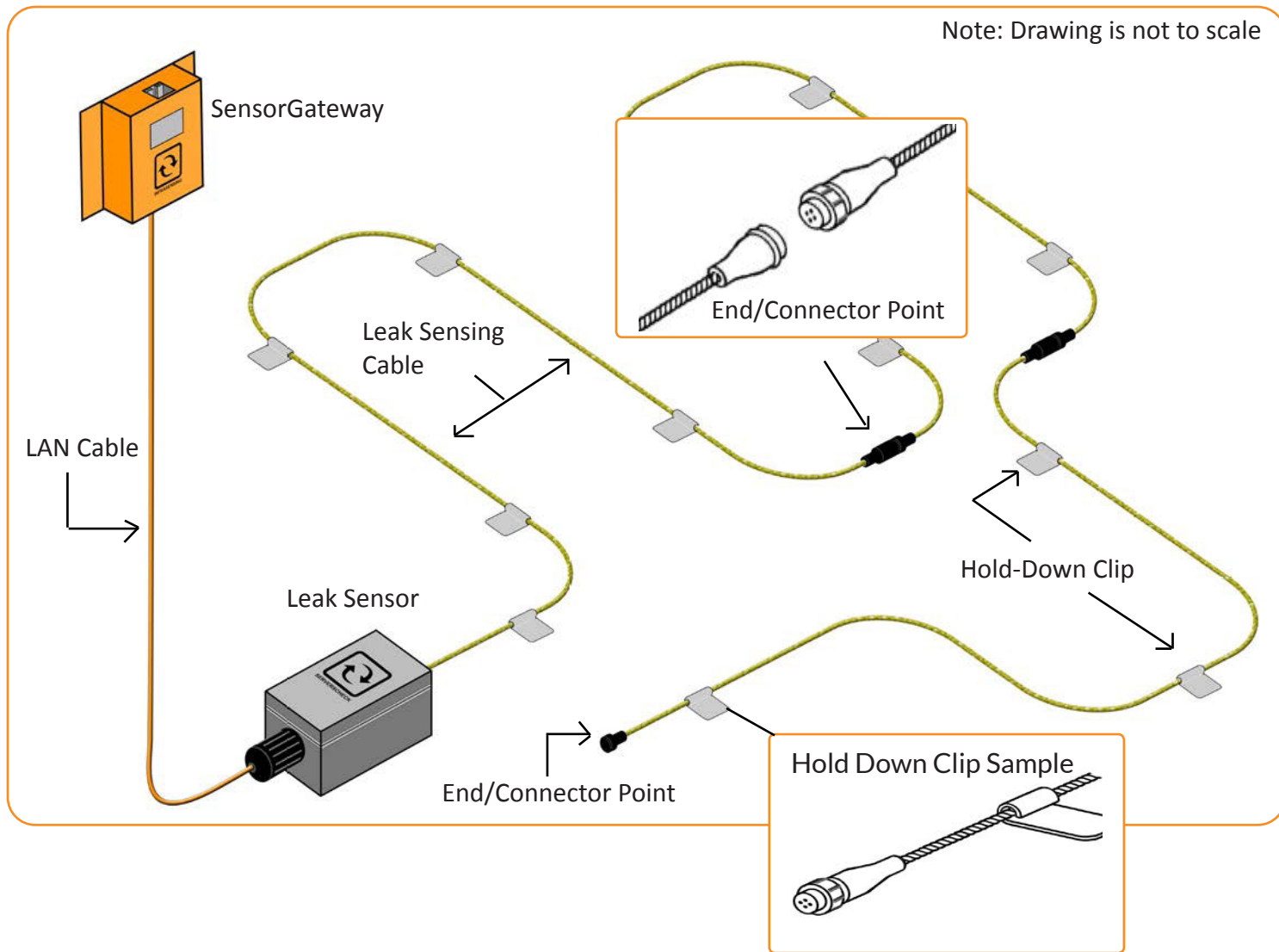



Installation steps

Prepare the area

1. Verify that there are no constructions present,
2. Clean the area where the cables will be installed,
3. Install the Hold Down clips.

Note:

Position the Hold Down clips so that you can place the sensing cable in the desired area and make sure that the adhesives are already dry before installing the sensing cable.

Prepare the Leak Sensor

1. Make sure that each sensing cable is intact and free of contamination.
2. Do not use damaged cables.
3. Observe the Do's and Dont's.
4. Connect the Sensing cable to the Leak sensor.

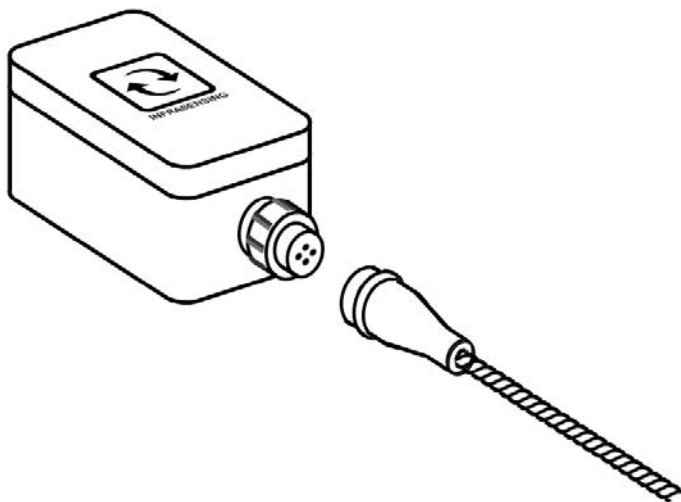



5. For multiple sensing cables, connect to form desired length.

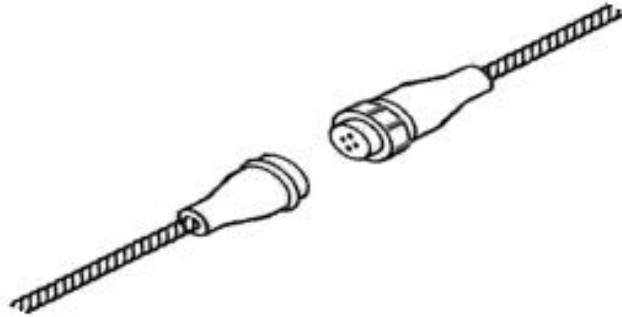

6. Take care to avoid damage and contamination of the sensing cable when being transported to the install location.

How it works

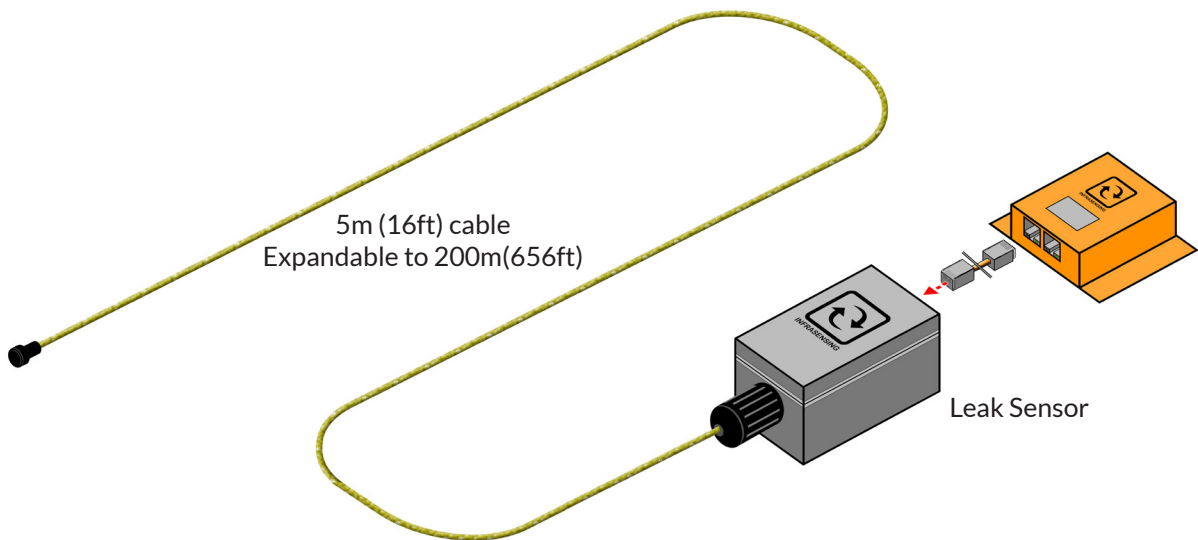

Once the sensing cable detects the Leak (water, battery acid or fuel depending on the cable you used), information is then passed to the SensorGateway. This will then trigger an alert either through email, SMS, voice or an SNMP or Modbus compatible software of your choice.

We also invite you to watch a video we've made for this sensor on:

https://infrasensing.com/sensors/sensor_flooding.asp



Leak Location

Our Leak Location Sensor (ENV-WLEAK-LOC) works on the same principle as the traditional leak sensor but with the benefit of being able to pin point the location along the cable. The sensor detects leaks along its cable with an accuracy of up to 1m(3ft).

How it works

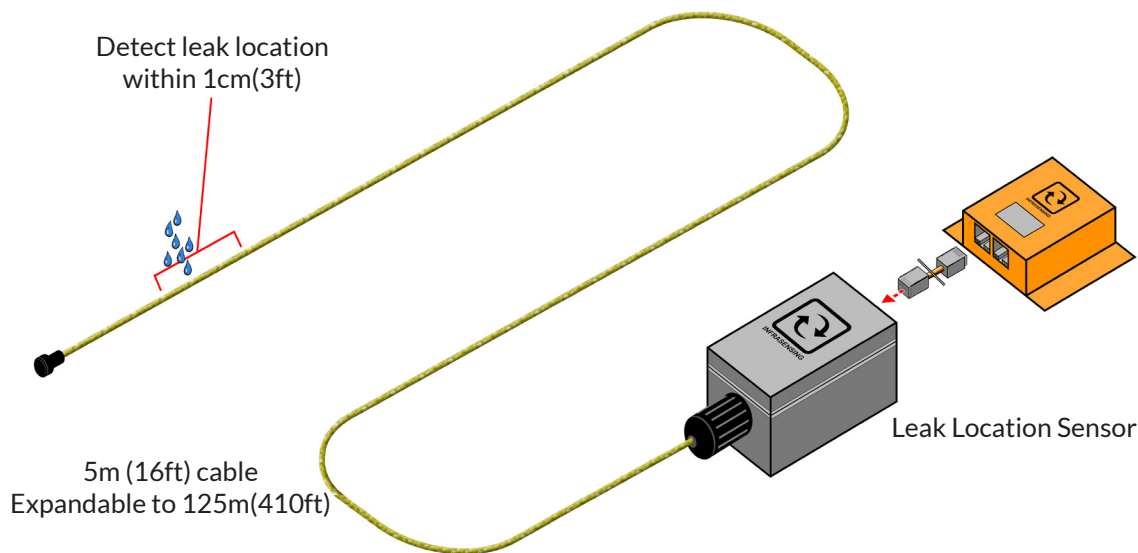

Once the sensing cable detects the water leak, the location of the leak is then passed to the SensorGateway. This will then trigger an alert either through email, SMS, voice or an SNMP or Modbus compatible software of your choice.

We also invite you to view the detailed specifications for this sensor on:

https://infrasensing.com/sensors/sensor_leak_location.asp



Installation tips

A typical Installation inside data centers, server & IDF/MDF rooms would be around Airconditioning units, pumps, windows, or any suspected areas that might be a source of a water leak.

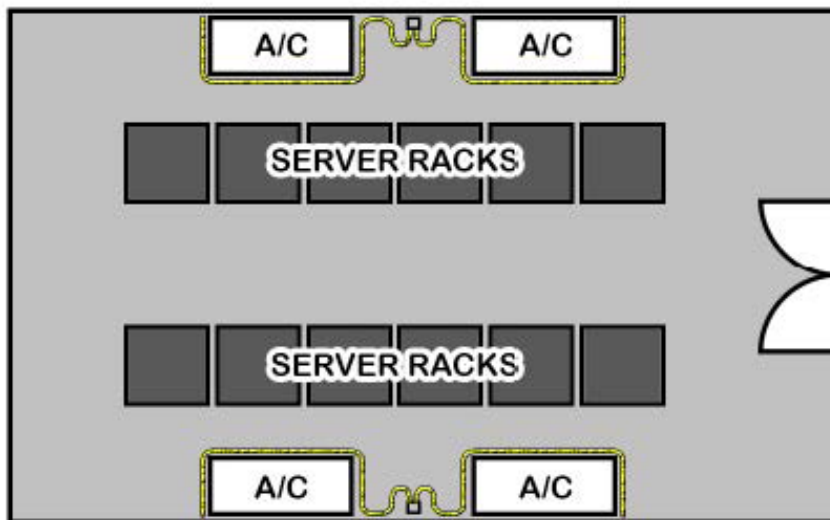

Another possible configuration is to install the water sensing cable around the equipment that you want to protect

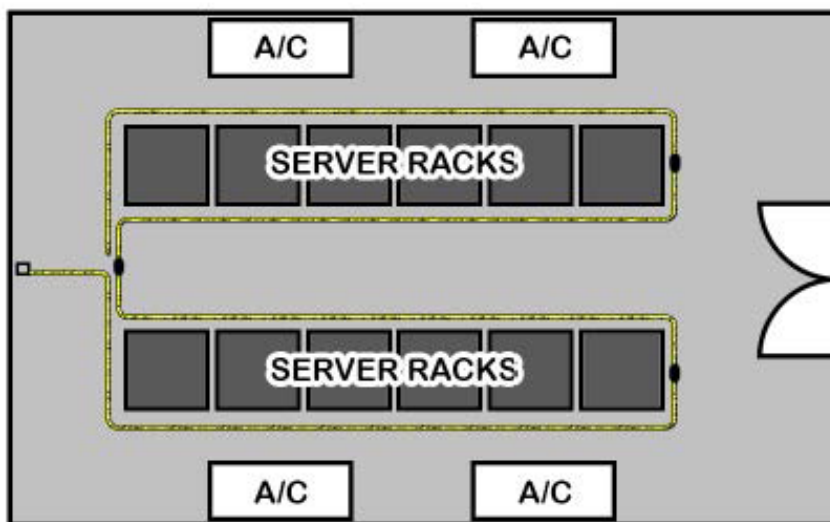



Installing under a raised floor

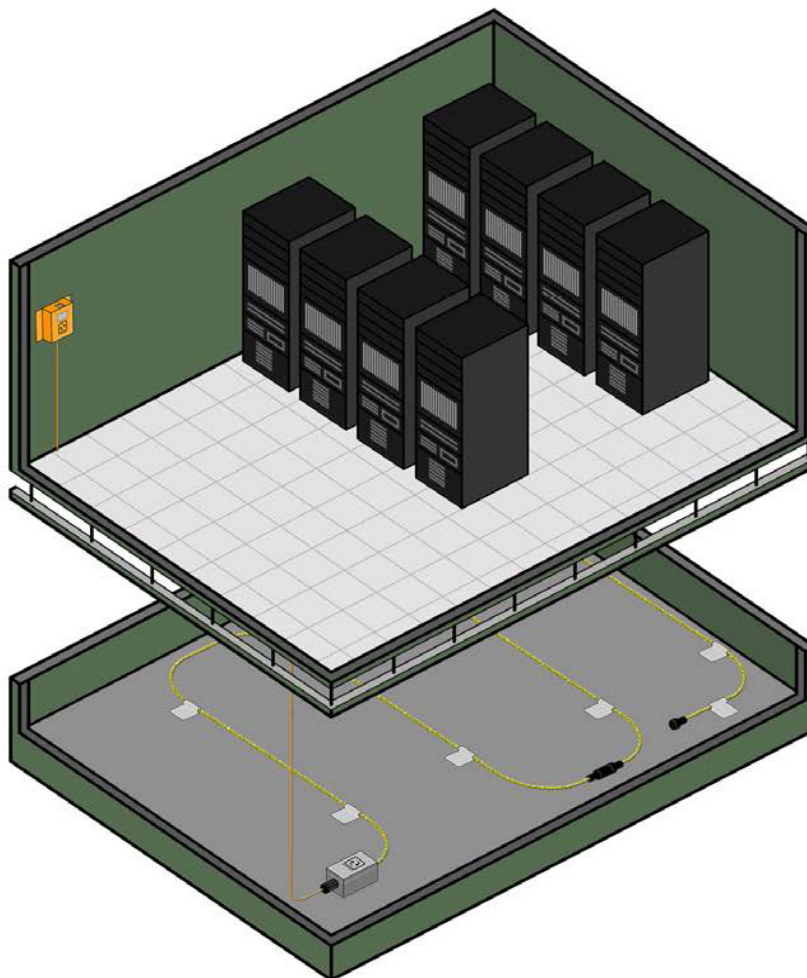

Here is another example on how to install the water sensing cables under raised floors of a server room. Usually the cable is set around the room, but it is also a good practice to cover the entire area if possible to ensure maximum protection.

In this case, you would be needing a longer water sensing cable. Simply connect additional water sensing cables, and extend your total length up to 200m/656ft (water leak) or 125m/410ft (water leak location).

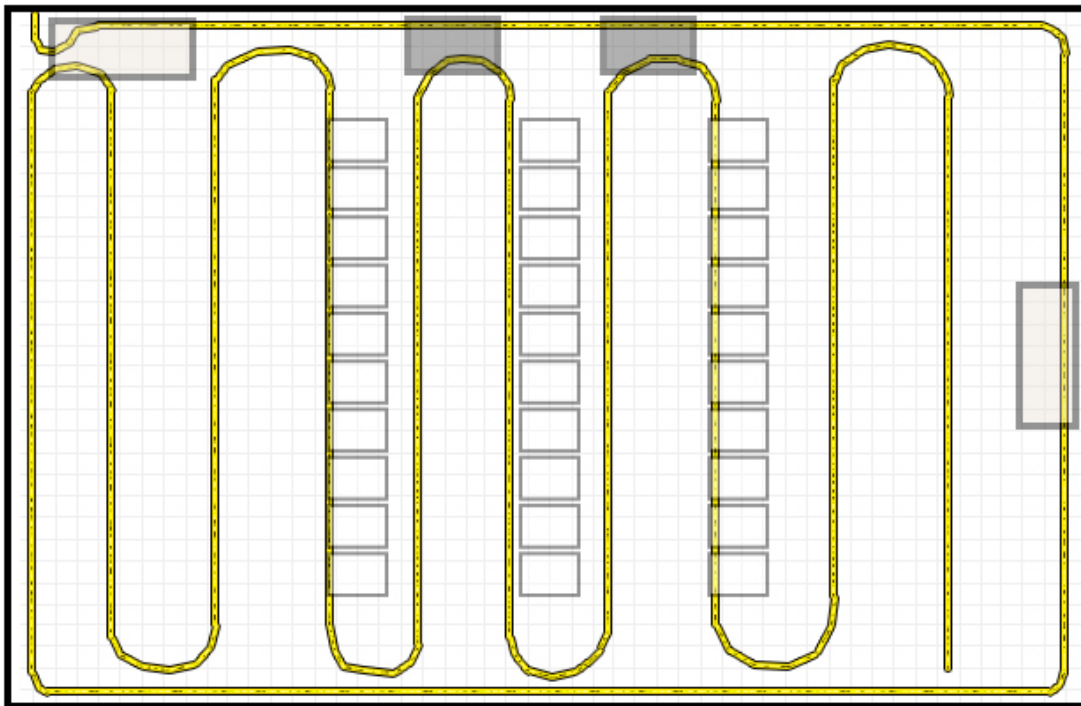

In this illustration, we can see the top view of the previous image. The water sensing cable goes around the room, and snakes in the center to cover the floor. Please do note that this is only an example, and actual installation would depend on how large your room is, the shape of the room, and the coverage you require. In some cases, you would need a few Base units and Water sensing probes, depending on how you set it up.

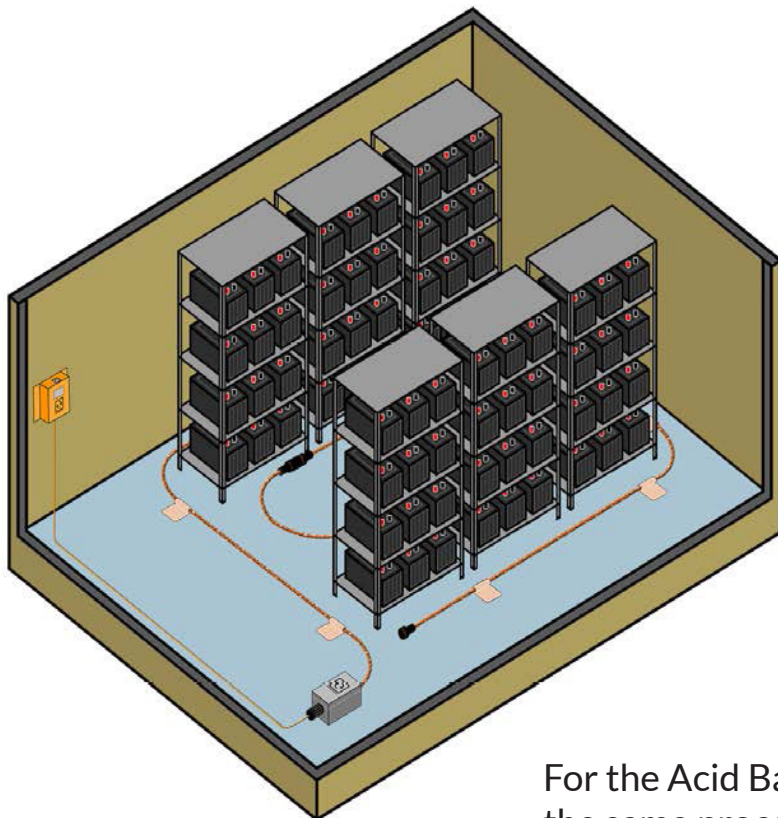

For the Acid Battery Leak Sensing cable the same procedure is applied, We need to make sure we cover possible points where leak can occur

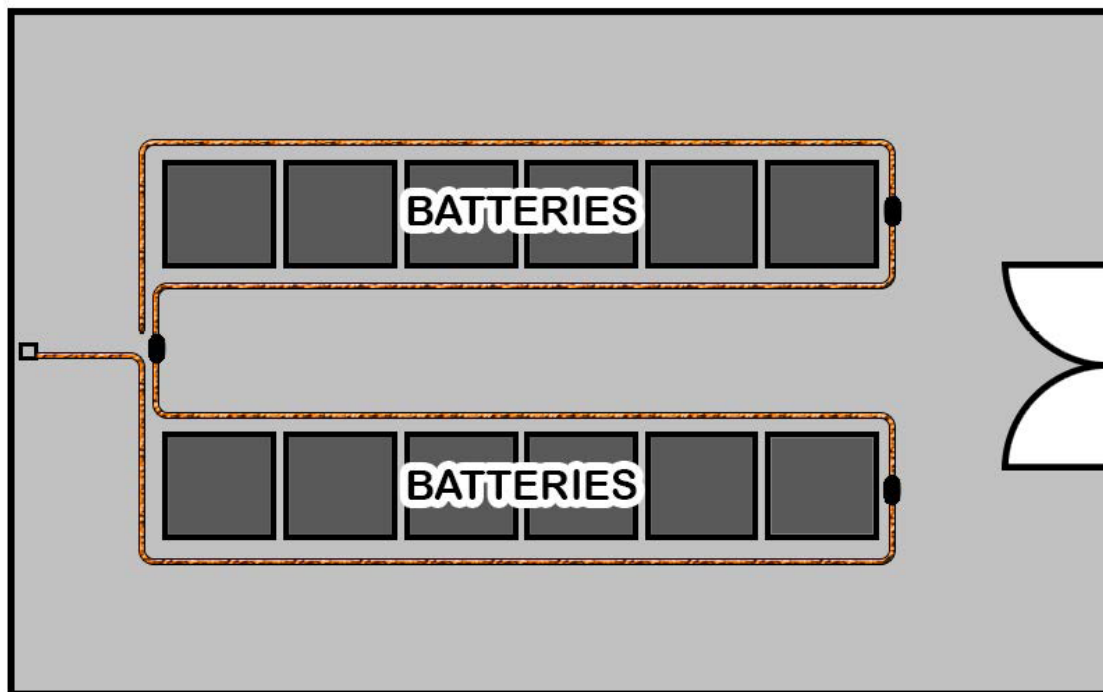

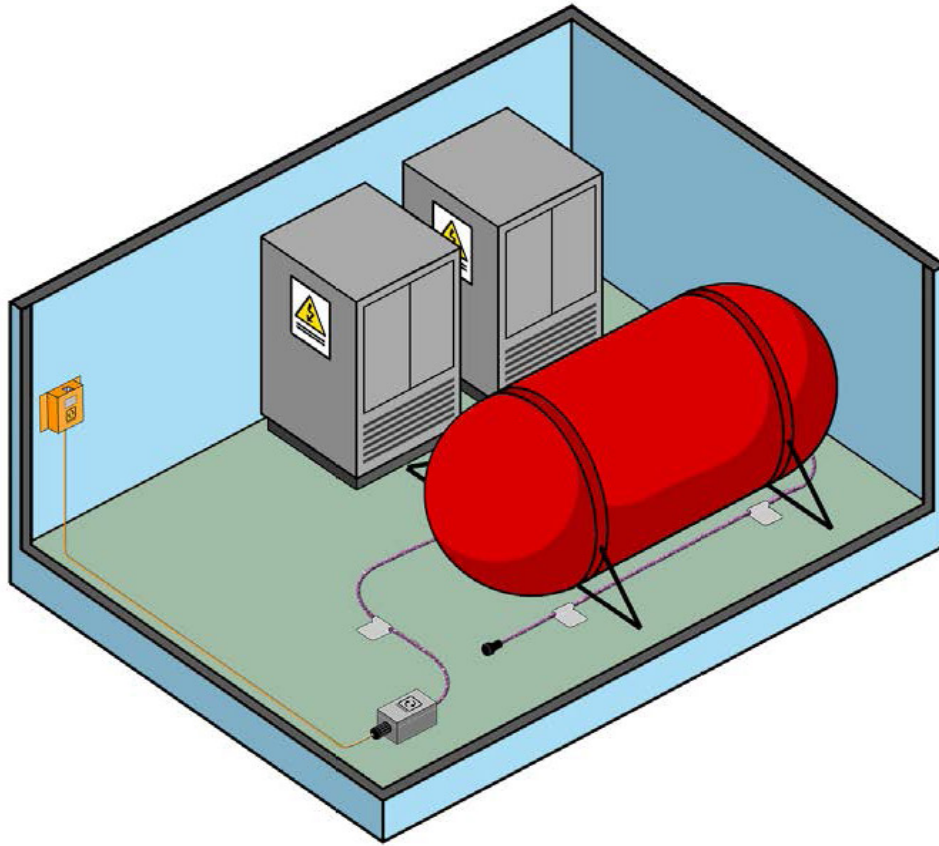

The same procedure is applied when setting up the Fuel Leak Sensing cable

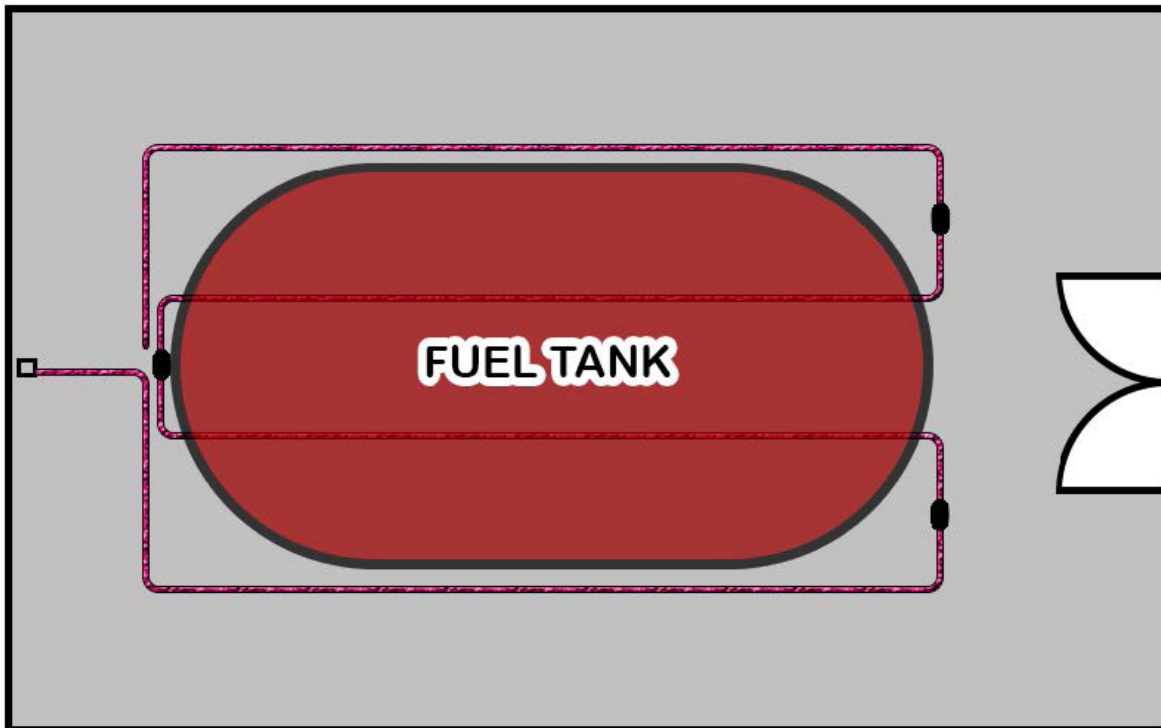



Applications

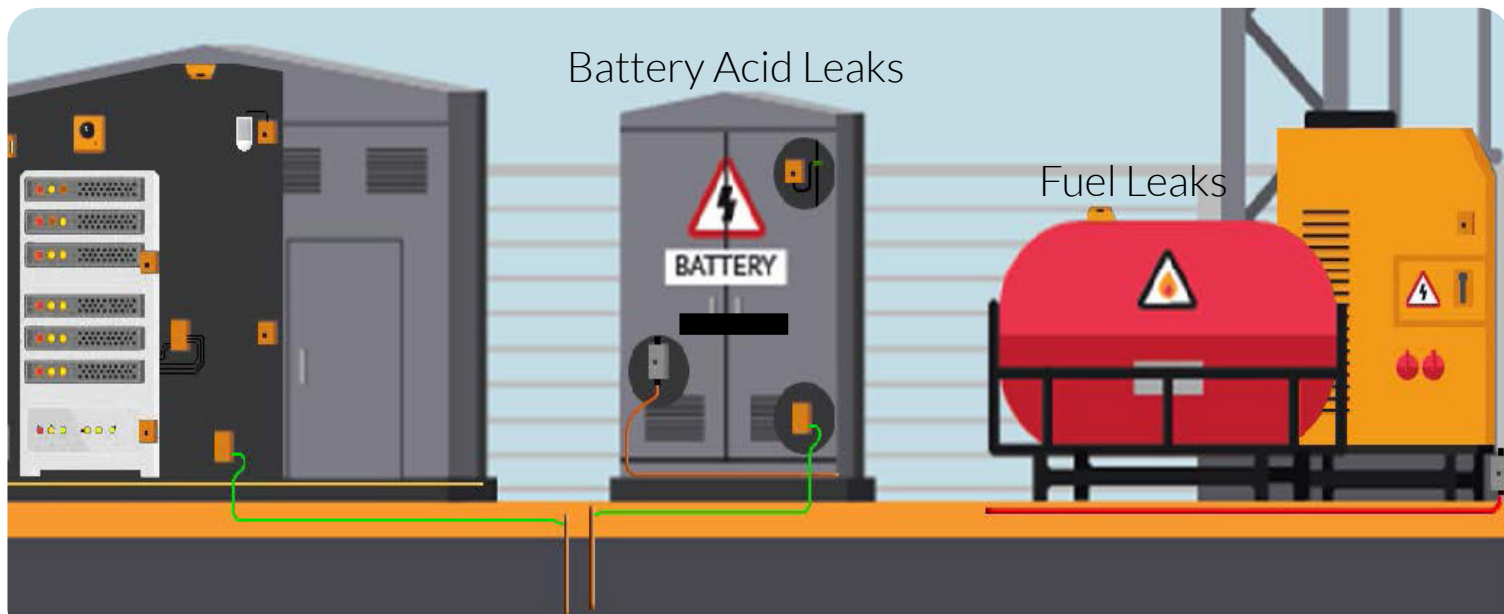

- Computer rooms beneath raised floors
- Server/communication rooms to detect water leaks above racked equipment
- Mechanical equipment to detect water leaks from HVAC units, pipes and fittings
- Water supply lines to detect water leaks from suspended hot or chilled water pipelines
- Critical equipment to detect water ingress into electrical pits, trenches and other important areas
- Generator Rooms
- Battery Rooms
- Fuel Tanks above ground
- UPS (Uninterruptible Power Supply) units
- Engine Rooms (within operating range)
- Building service columns to locate leaks near plumbing and electrical accesses to warn about leakage to the floors below



More applications

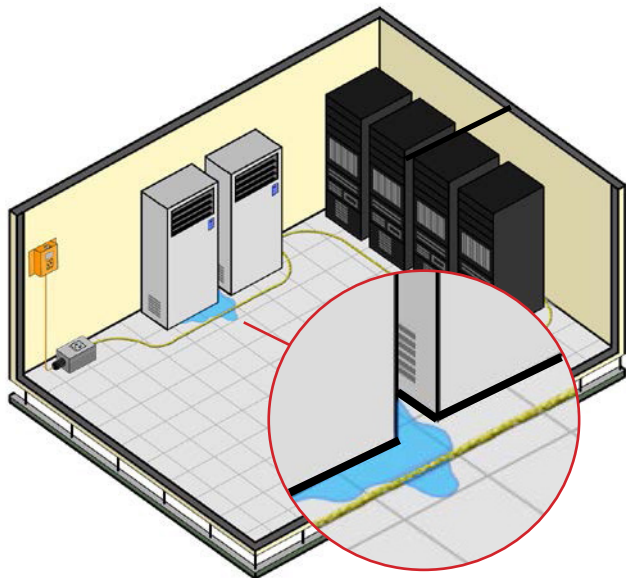

Around air conditioning units

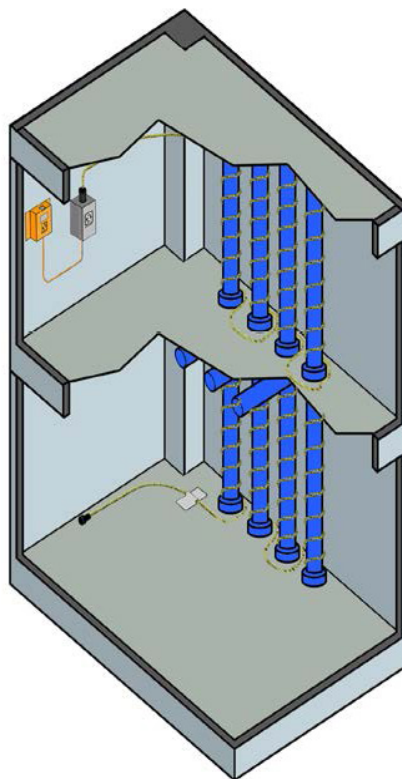

Install it in building columns, near drain pipes and plumbing

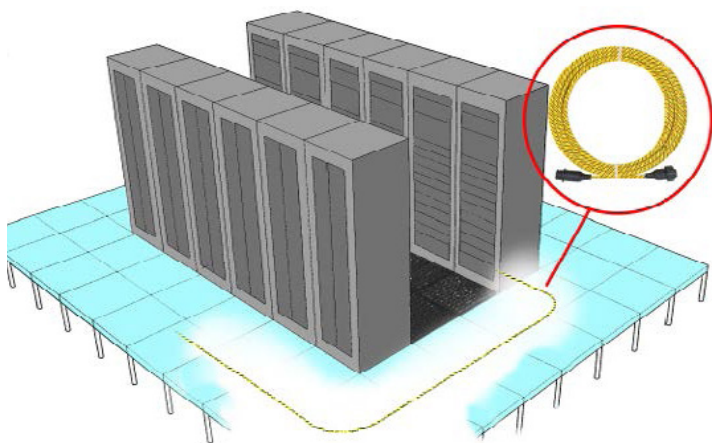

Data centers under raised floors

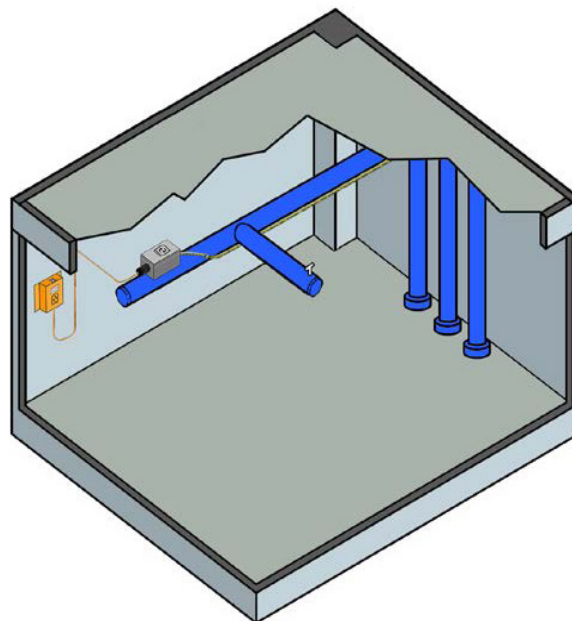

Overhead pipes, sprinklers, and water cooling systems



Integrating with ServersCheck

Getting an alert when a leak is detected is great. But where is it? Seeing a visual representation of leaks is what makes the difference. And that's what ServersCheck does.

With the latest edition of our Monitoring Software or Monitoring Appliance you can now plot the leak sensors on your floor plans, building maps and the software will automatically change the color when a leak is detected.

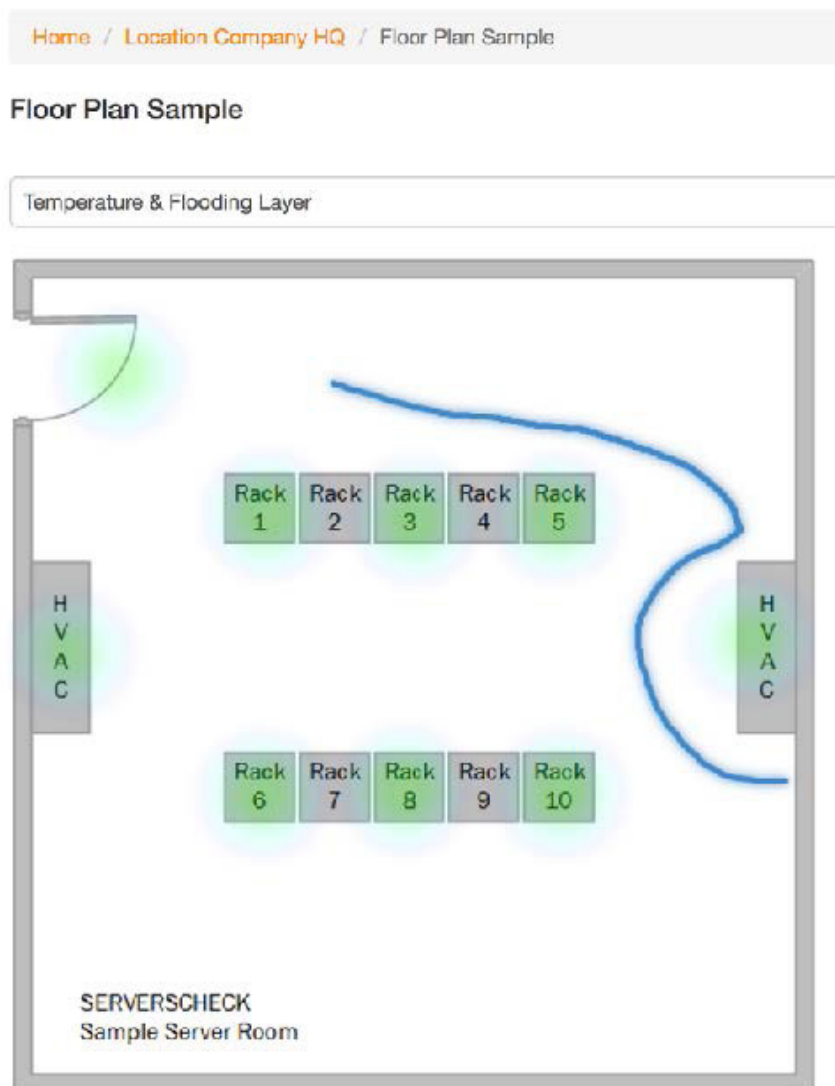

We invite you to check our software, It is free for personal or non-profit use.
<https://infrasensing.com/monitoring-software/>



Integrating with your software

The SensorGateway (base unit) supports 4 protocols: SNMP , Modbus TCP, JSON and XML.

Following is a list of online resources showing you how to integrate our sensors with 3rd party software and other systems using the standard communication protocols available in the base unit.

SNMP Monitoring Systems

The base units support 2 methods of SNMP:

- SNMP Get: requests can be made to the SensorGateway using SNMP v2 or v3
- SNMP Traps: you can use SNMP v1 and v3

We have created guides on how to integrate our solution via SNMP in some of the leading softwares.

<https://infrasensing.com/sensors/api.asp#nms>

Building Management & Automation Systems

ServersCheck's base units support next to SNMP the Modbus TCP protocol which enables to integrate the sensors with Building Management Systems (BMS)

We have created a user manual on how to integrate our solution via ModBus TCP through this link.

<https://infrasensing.com/sensors/api.asp#bms>

Middleware, scripts and other software

Our solution can also be integrated into your own scripts , web page, middleware or other software. More information can be found on the link below.

[JSON](#)

[XML](#)

[Command Line](#)

Should you know of another online resource about integrating our sensors with other platforms, [Contact us](#) and we'll add it to the list.

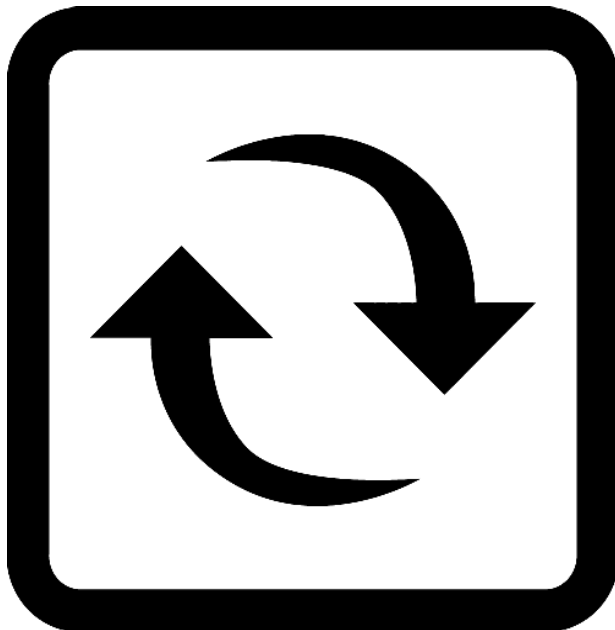

INFRASENSING

Phone : +1-800-550-29-75

Fax: 1-800-520-4393

<https://infrasensing.com>

WhatsApp 

Messenger 

Twitter 

Email 

SMS 

Live Chat 